

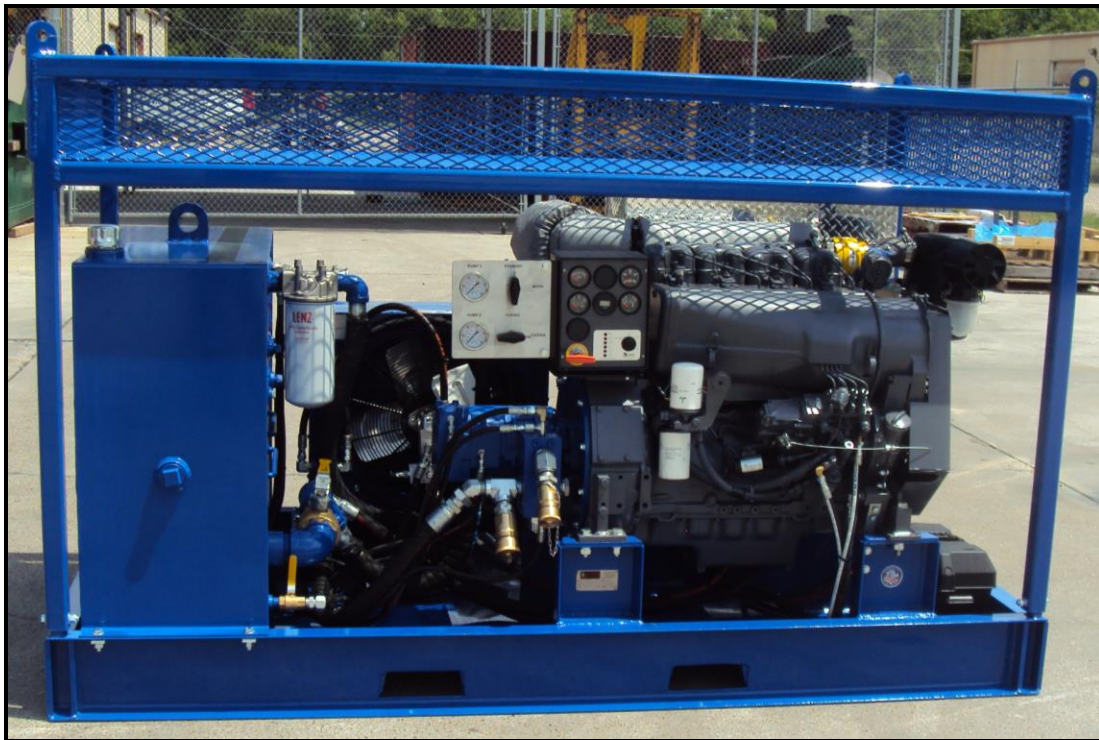

Model 30800 DHPU  
Casing and Tubing Tong Diesel Hydraulic Power Unit  
Installation, Operation, Service and Parts Book Manual



WPI WELLKIN Inc.  
8401 Industrial Dr.  
Pearland, TX 77584  
PH: (281) 992-2064  
FX: (281) 992-2076  
E-mail: [sales@wpiwellkin.com](mailto:sales@wpiwellkin.com)  
Web: [www.wpiwellkin.com](http://www.wpiwellkin.com)

---

## **Terms and Conditions**

1. All WPI WELLKIN packing slips and invoices must show Buyer's purchase order number.
2. All shipments MUST contain packing slips.
3. **CONTRACT:** This order will become a binding contract upon receipt by WPI WELLKIN of Buyer's PO, receipt by Buyer of a written acknowledgement by WPI WELLKIN and receipt by WPI WELLKIN of a down payment in the amount specified in the contract.
4. This contract may be modified as mutually agreed by the Buyer and WPI WELLKIN.
5. **PAYMENT TERMS:** The payment terms are specified on the commercial offer from WPI WELLKIN. The Buyer agrees to the payment terms by acceptance of the bid.
6. **DELIVERY:** Time is of the essence. WPI WELLKIN will attempt to deliver the material early if possible. WPI WELLKIN will make best efforts to supply all material on a timely basis. If the delivery will run over the contract delivery date, WPI WELLKIN will notify the Buyer giving reason for delay. The current delivery estimate is specified on the commercial offer. The Buyer agrees to the delivery terms by acceptance of the bid.

When necessary, WPI WELLKIN will notify the Buyer in advance of completion of the order and Buyer will appoint an authorized representative or employee to inspect the material on a date and site as designated by WPI WELLKIN. Transportation, lodging and all other expenses portal to portal for Buyer representative or employee to witness and accept the material is the expense of the Buyer.

All costs associated with preparation, crating, insurance and ocean freight of the goods to the final destination to be at Buyer's expense.

7. **CANCELLATION:** This contract is considered to be special order and not subject to cancellation. Both parties hereto shall be given consideration in case of delays in delivery caused by fire, strike, riot, war, act of God, delay of carriers, governmental order or regulation, complete or partial shutdown of plant by reason of inability to obtain sufficient raw materials or power or any other similar or different contingency beyond the reasonable control of the respective parties.
8. **WARRANTIES AND REMEDIES:** WPI WELLKIN expressly warrants that all supplies, materials and parts covered by this contract will conform to the specifications in the contract as applicable and will meet or exceed industry standards for such equipment. WPI WELLKIN will supply Buyer with operations manuals and parts books for the material where applicable. Certificates of Compliance are available upon request.

**MANUFACTURED ITEMS:** WPI WELLKIN manufactured items must be free of material and workmanship defects for a period of 6 months from the date of delivery. If any items fail because of a manufacturing defect within that period of time, then that item will be replaced by WPI WELLKIN. Expendable / wear items are not covered under warranty. Examples of such items include, but are not limited to, the following - dies, inserts, brake bands, rollers, gears, chains, filters, belts, flexible couplings, slip bodies, spider bowls.

---

Replacement of parts will be accomplished at WPI WELLKIN's facility or at a designated service point. WPI WELLKIN's liability is limited to replacement of defective parts only and does not include the cost of labor, communications, transportation or handling connected to the replacement of these parts. WPI WELLKIN will in no event be liable for consequential damages or contingent liabilities arising out of the failure of any parts to operate properly. No expressed, implied or statutory guarantee other than herein set forth is made or authorized to be made by WPI WELLKIN.

**DISTRIBUTED ITEMS:** Items distributed by WPI WELLKIN are subject to the warranty provided by the Original Equipment Manufacturer (OEM). Upon request, WPI WELLKIN will furnish Buyer with a warranty statement from the OEM for the applicable material. The OEM warranty will start on the items' delivery date.

9. **COMMISSIONING:** On request, WPI WELLKIN can supply a representative for material commissioning. The Buyer is responsible for portal to portal transportation costs and the current WPI WELLKIN day rate.

10. **BUYER'S PROPERTY:** All equipment or material furnished by WPI WELLKIN shall be the property of the Buyer after the WPI WELLKIN invoice is paid in full.

11. **PATENTS:** WPI WELLKIN holds the Buyer harmless from all claims, for infringement or alleged infringement of any patents arising out of the sale or use of the goods furnished pursuant to this contract.

12. **INDEPENDENT CONTRACT:** In the event that any goods ordered hereunder require in connection with the installation thereof, the services of a contractor engaged by WPI WELLKIN or a supervisor, engineer, or other employee connected with or employed by WPI WELLKIN, and WPI WELLKIN agrees to furnish same, either with or without charge, such contractor, supervisor, engineer, or other employee in performing such services shall not be deemed to be the agent or employee of the Buyer.

13. **INSURANCE:** WPI WELLKIN agrees to carry General Operations and Liability Insurance and other coverage as required in accordance with applicable state and federal laws of the U.S.A.

14. **COMPLIANCE WITH LAWS:** WPI WELLKIN warrants that in its performance of this contract it will comply with all applicable Federal, State and Local laws, regulations, rulings and orders of the U.S.A.

15. **ASSIGNMENT:** This contract may not be assigned without the written consent of the Buyer and any attempted assignment thereof shall be void.

16. **PROPRIETARY INFORMATION:** All plans, drawings, specification and the subject matter contained therein and all other information given to WPI WELLKIN in connection with performance on this Purchase Order involve valuable property rights of the Buyer and shall be held confidential by WPI WELLKIN, shall remain the property of the Buyer and shall not be used by WPI WELLKIN for any purpose other than those for which they have been prepared or supplied. WPI WELLKIN agrees that, as far as possible, it will keep confidential the making of this order and the terms hereof. WPI WELLKIN agrees not to use for publicity purposes any information as to notice of receipt of order, photographs, drawings and/or materials in connection with performance of the Order without obtaining the prior written consent of the Buyer.

---

## **Table of Contents**

Terms and Conditions.....	2
Warnings.....	5
General Information.....	7
Transportation and Installation.....	8
Operation.....	12
Appendices.....	26

## **List of Figures**

Figure 1: Transportation Points.....	8
Figure 2: Engine Motor Oil.....	10
Figure 3: Engine Fuel Tank and Filters.....	10
Figure 4: Hydraulic Tank Level Gauge and Fill Location.....	11
Figure 5: Quick Disconnects and Ball Valves Location.....	12
Figure 6: Control Panel.....	13
Figure 7: Hydro-Throttle.....	14
Figure 8: Return Pressure Gauge.....	14
Figure 9: Engine Exhaust Components and Over Speed Shutdown.....	15
Figure 10: Fan Belt Break.....	16
Figure 11: System Relief and Pump Sequence Valves.....	17
Figure 12: Heat Exchanger and Pump.....	18
Figure 13: Heat Exchanger Valves.....	19
Figure 14: Suction Strainer and Return Filter.....	19

## **List of Tables**

Table 1: Troubleshooting the Power Unit Engine.....	20
Table 2: Troubleshooting the Power Unit Hydraulic Circuit.....	22
Table 3: One Year Spares.....	25
Table 4: Two Year Spares.....	26

---

## Warnings

The Diesel Hydraulic Power Unit (DHPU) design integrates several safety features. However, the power unit is only as safe as the operator using it. Therefore, it is imperative that the operator and all other workers around the power unit observe the warnings below as well as read and understand this manual. Failure to follow the instructions could result in **death, serious injury or equipment damage**. The manufacturer is not responsible for any damages resulting from misuse of the equipment. The risks and consequences of misuse are the responsibility of the user.



- Observe, understand and follow all safety warnings.
- This power unit is built strictly for generating hydraulic power for casing or tubing tongs. Any use of the power unit contrary to the design is absolutely prohibited.
- Never operate the power unit above the rated design pressure or engine speed.
- Always check the pressure setting of the power unit before operating to prevent equipment damage.
- Never add, remove or convert equipment on the power unit without prior consent.
- Never defeat or remove any of the power unit's integral safety features.
- If a leak is observed, then halt the operation of the power unit and repair the leak immediately.
- Use the recommended size of interconnect hose with the proper pressure rating.
- Keep all body parts and clothing away from moving machinery.
- Only trained personnel should operate, adjust or repair this equipment. No weld repair on any components is allowed. Any attempts to repair these items by welding will void all warranties and liability.
- Use industrial safety regulations for proper ventilation of potentially poisonous exhaust fumes when operating the power unit in a confined or enclosed space.
- Prior to servicing the unit (maintenance, repairs, valve adjustment, etc.), shut down and disconnect or kill power to the unit. Then, disconnect the hydraulic connections

---

from the power unit before performing any service. Allow the engine to cool down before working around it to make repairs.

- All personnel working around the power unit shall wear protective clothing including but not limited to the following.
  - Hard hat
  - Eye protection
  - Safety boots with steel toe
  - Safety gloves
  - Ear protection
  - Coverall
  
- Never use excessive force when coupling the wingstyle quick disconnects to the system.
  
- Never disconnect any hose on the power unit when it is in operation. All hoses must be pressure free before they are disconnected.
  
- Use only the identified areas on the power unit for lifting the unit. Ensure that any lifting equipment is rated for the power unit weight, and all equipment used in lifts should be current with its inspection paper work.

---

## **General Information**

### **Description**

This DHPU model is an open frame type power unit designed to provide hydraulic power to an open center circuit such as a casing tong, tubing tong or other open centered circuits. The unit is self contained.

The DHPU is powered by an air cooled, 4 cylinder Deutz diesel engine. Attached to the engine is a two section gear pump. Both sections provide fluid power to the casing circuit. When the tubing tong circuit is active, fluid power only comes from one section of the gear pump. There is an auxiliary hydraulic pump mounted on the engine to provide fluid power for the heat exchanger motor. Also included within the unit are the following items.

- Instrument panel with engine speed, temperature and pressure
- Electric start with battery (shipped dry to international destinations)
- Safety package with automatic over speed shutdown, emergency manual air intake shutdown and spark arrestor
- Shutdowns for low oil pressure, high oil temperature and fan belt break
- 45 gallon diesel reservoir with level gauge, drain port w/ ball valve and filler breather
- Hydraulic throttle
- System relief valve set at 2500 PSI
- Air/oil heat exchanger with hydraulic motor
- 100 gallon hydraulic reservoir with baffle, level gauge, oil temperature gauge, cleanout cover, suction strainer with isolation ball valve, return filter, return pressure gauge, drain port with ball valve and filler breather
- Panel with 0 to 5000 PSI pressure gauges, control valves for standby/work and casing/tubing modes
- Oilfield type base skid with drip pan, drain ports and fork lift pockets
- Lift cage with hose basket
- Aluminum diamond plate box for small parts and tool storage

### **Specifications**

#### Fluid Power

Tubing tong circuit	2500 PSI @ 30 GPM (172 bar @ 113 LPM)
Casing tong circuit	1250 PSI @ 60 GPM (86 bar @ 227 LPM)

#### Weight

Dry (Without fuel and hydraulic fluid)	3500 lbs (1588 Kg)
Wet (With fuel and hydraulic fluid)	4500 lbs (2041 Kg)

#### Connections (5100 Series Wingstyle Disconnect)

Pressure	1" Male
Return	1-1/4" Male

#### Dimensions

Length	96" (2438.4 mm)
Width	48" (1219.2 mm)
Height	62" (1574.8 mm)

---

## **Transportation and Installation**

Before any attempt is made to operate the power unit, the following section should be read, understood and then followed.

### **Transportation**

The power unit has several options for transportation as demonstrated in the picture below. No special regulations apply to the transportation of the power unit.

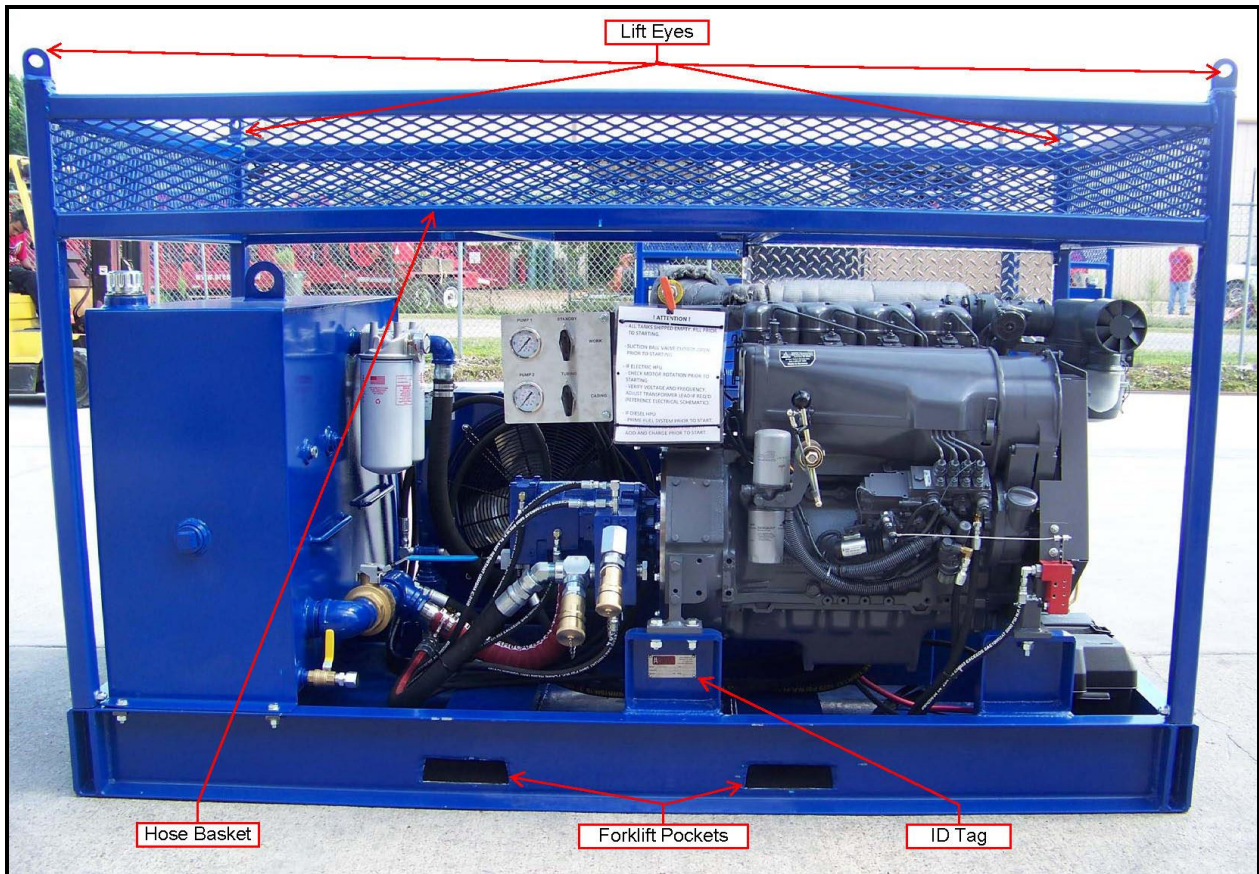

**Figure 1: Transportation Points**

#### ***Lift Eyes***

The power unit is designed to be lifted by the four lift eyes on top of the hose basket. When lifted, a sling with four legs is required, and the sling must, at a minimum, be rated for the gross weight of the power unit. The lifting equipment should also be inspected to ensure it is in adequate condition. Normal rules and safety precautions apply when lifting the unit.

#### ***Forklift Pockets***

Incorporated into the base skid are two forklift pockets. Ensure the forklift used to lift the unit has long enough forks to span the entire width of the pocket and is rated to lift the unit.

#### ***Hose Basket***

The hose basket provides a storage area for the hydraulic hoses as well as spare components.



---

## ***ID Tag***

Each unit has an identification tag installed on the skid. Use the ID tag information (weight, model, serial number, etc.) for transportation documentation.

## **Installation**

Once the power unit is on location, then the installation process gets the unit ready for operation.

### ***Location of the Unit***

Remember the following points when positioning the power unit for installation.

- The physical space required for the unit is detailed in the general specifications page. Consideration should also be given for access around the power unit for startup procedures and maintenance activities.
- The power unit should be located on an area that is relatively flat. Installing the unit on an incline could adversely affect the fluid levels of the motor oil and hydraulic fluid.
- Also, take into account the location of the power unit to keep it as close as possible to the equipment in order to reduce pressure losses in the line. Pressure losses from long hose lengths can reduce the system performance and generate significant heat.
- Ensure the exhaust and intake air paths are unobstructed. The engine exhaust should be directed towards a well ventilated area and pointed away from any operator positions.
- If located near an operator, then proper safety equipment such as ear protection should be worn by all personnel near the unit.
- The diesel power unit incorporates several safety devices. However, this combustion engine driven power unit is neither designed nor certified as an explosion proof system.
- The unit will require diesel fuel, engine oil and hydraulic fluid to be added or removed during operation or maintenance. Take precautions when adding new fluids to avoid spills and dispose of used fluids according to the applicable local environmental laws.

### ***Engine System Inspection***

Examine the following areas on the diesel engine after the unit is in its final position. Do not inspect the engine while it is running. Review the included engine manuals for detailed instruction.

- With the power unit on level terrain, check the motor oil level using the dipstick. The level should be between the minimum and maximum marks. Add motor oil to the inlet if the level is below the minimum mark. Refer to the engine manual for the type of motor oil required. As a general rule, use SAE 10W-30 motor oil for average ambient operating temperatures below 45°F (7°C), SAE 15W-30 for 45° to 85°F (7° to 30°C) operation and SAE 15W-40 for operation above 85°F (30°C). If the oil level is above the maximum mark, then drain the motor oil level out of the outlet.
- It may be necessary to purge the fuel system from air that may have been introduced during transportation, during repair/maintenance work or if the system ran until the fuel tank was empty. If air bubbles are in the fuel system, the power unit will have

difficulty running or may not run at all. See the following figure for the location of the priming pump. Reference the engine manual for procedures to bleed the fuel system.

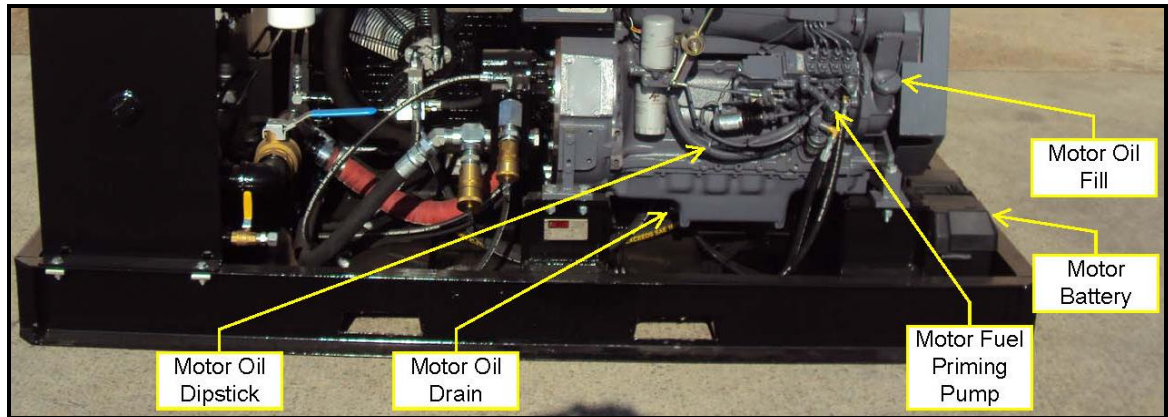

**Figure 2: Engine Motor Oil**

- On international shipments, the motor battery is shipped dry. Fill and charge prior to use. Then, connect the motor leads to the battery.
- Check the fuel level in the diesel tank. Add fluid through the fluid fill port. Commercial grade diesel fuel should be used. Refer to the engine manual for details on summer or winter grades of diesel fuel. When filling the tank, do not spill any fuel and avoid letting contaminants enter the tank. The following photo shows the fuel tank location.
- Refer to the engine manual for service and maintenance schedules for the motor fuel filter and oil filter. These filters ensure the purity of the fuel and oil reaching the engine systems. If necessary, then replace the filters per the instructions in the manual prior to operation.

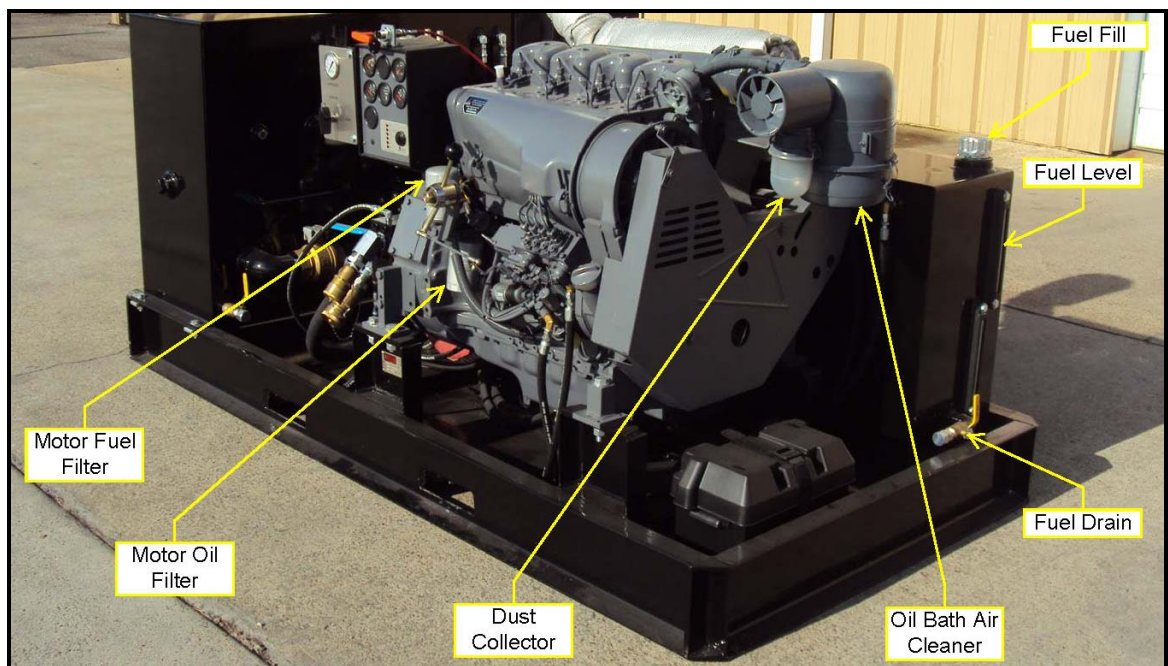

**Figure 3: Engine Fuel Tank and Filters**

- Remove all debris and coarse dust from the collector prior to starting the engine. The previous photo shows the location of the dust collector. Review the service and maintenance section of the engine manual for further instructions.
- Check the oil condition and level in the oil bath air cleaner. If the oil needs replacement, then follow the instructions for cleaning and replacement in the engine manual. The cleaner is detailed in the previous photo.

### ***Hydraulic System Inspection***

The following steps review the hydraulic system to ensure it is ready for operation.

- Check the fluid level of the hydraulic tank. For optimum operation, the fluid level should be kept near the maximum fill line as detailed in the following photo. If the level is low, then add hydraulic fluid through the filler/breather until the level reaches the top of the level gauge. When the filler/breather cap is removed, take care to avoid the passage of contaminants into the hydraulic reservoir. A premium hydraulic fluid is recommended for use such as Shell Tellus® S2 M 32 for average ambient operating temperatures below 45°F (7°C), Shell Tellus® S2 M 46 for 45° to 85°F (7° to 30°C) operation and Shell Tellus® S2 M 68 for operation above 85°F (30°C).
- The level gauge has a built in thermometer that displays the temperature of the oil in the reservoir. The power unit should not be operated when the oil temperature is above 160°F (71°C).
- Open the louvers on the heat exchanger prior to operation. They are closed for transport to protect the heat exchanger core.

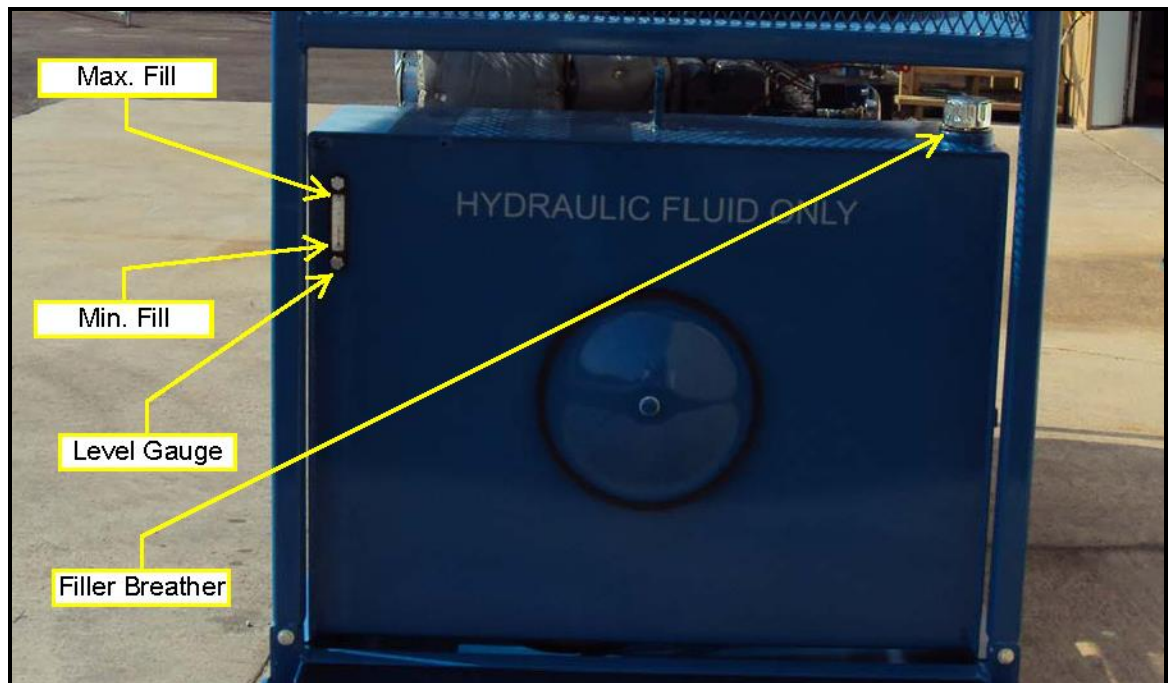

**Figure 4: Hydraulic Tank Level Gauge and Fill Location**

- Ensure the suction line ball valve is in the open position. Starting the unit with the ball valve closed will cause serious damage to the hydraulic pump. The ball valve is mounted on the suction port of the tank.

- Verify the interconnect hoses or piping is adequate for the maximum flow generated from the power unit. Undersized lines will lead to a buildup of heat and a decrease in system performance. A hose set can be purchased separately with connectors matching the power unit installed.
- For quick installation and to reduce spills on connection, the power unit is equipped with quick disconnects. Never connect or disconnect the lines when the power unit is running. Before connecting the quick disconnects to the unit, ensure that the faces of the connectors are free from debris. Remove any particles with a lint free rag. Dust plugs and caps are included with the connectors to prevent contamination during transportation and storage. Connect the pressure and return lines using the quick disconnects. The connectors are threaded with a wing style construction. Full thread engagement must be met before the integral check valve in the connector is forced to open. The following photo shows the location of the pressure and return quick disconnects.

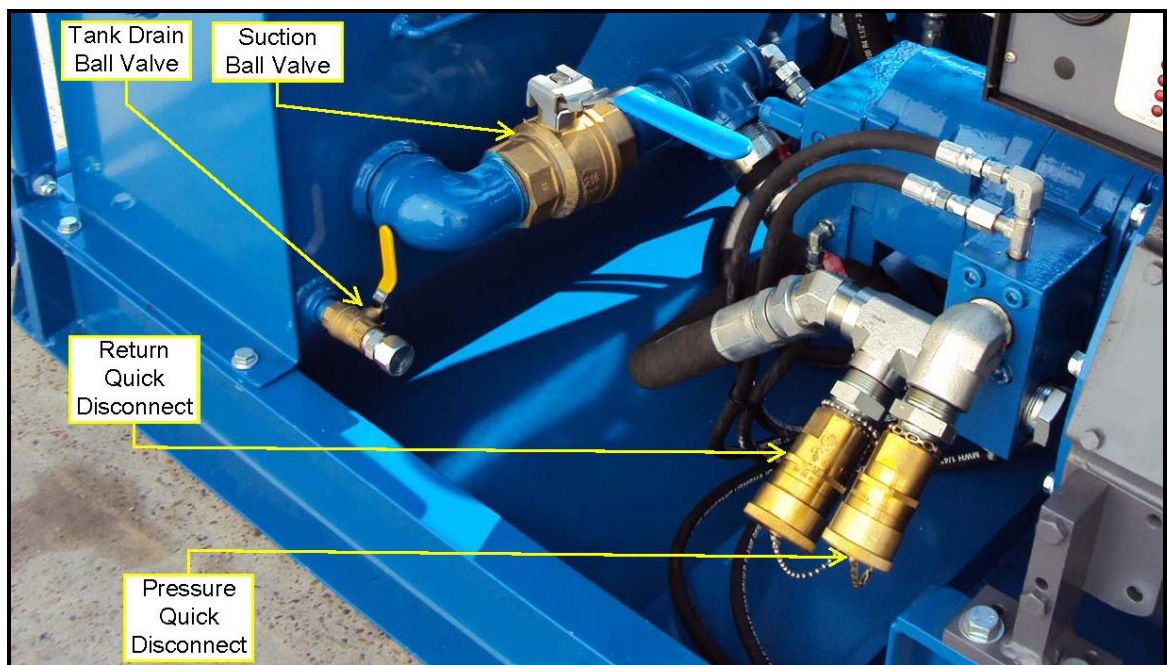

**Figure 5: Quick Disconnects and Ball Valves Location**

## **Operation**

The DHPU is a simple unit that provides pressure and flow for an open center hydraulic circuit such as a tong. This unit is not intended to work in conjunction with closed center valves. Closed center valves have the pressure port blocked in the neutral position. Heat builds up in the system quickly as the full flow of the system is dumped over the system relief since the flow cannot return to tank through the valve.

The prime mover for the hydraulic pump is the diesel engine. The engine rotates the pump shaft at the speed selected and the torque output is dictated by the load on the pump. This model has two fixed displacement gear pumps coupled to the engine. The first gear pump has two sections and provides hydraulic power to the open centered circuit. The other single section pump's purpose is to supply power to the heat exchanger's motor. It is mounted on the engine's auxiliary pad.

The following sequences assume the necessary installation steps have been completed, and the unit is ready for start up.

## **Modes**

The DHPU has the following modes of operation. Ensure the arrow on the selector handle aligns with the black lines on the panel when changing modes as shown in the picture.

### ***Standby Mode***

When the ball valve is in the standby position, flow is allowed to bypass the tong circuit and circulate internally back to tank. This feature does not shut off the tong circuit from seeing pressure. Do not perform maintenance on the tong or disconnect the hoses with the unit in standby mode. The unit can be placed in standby mode when starting the unit or when long breaks are expected in operation. Oil still flows through the heat exchanger, but the unit will generate less heat because flow is at zero pressure instead of the loop's back pressure.

### ***Tubing Mode***

The power unit should be in tubing mode when a tubing tong is to be operated. In this mode, flow from the rear section of the pump is diverted internally in the pump back to the suction port allowing only the front section to provide flow to the circuit. The maximum pressure allowed in the circuit is dictated by the relief valve mounted directly on the pump. Tubing mode provides lower flow but higher pressure than casing mode.

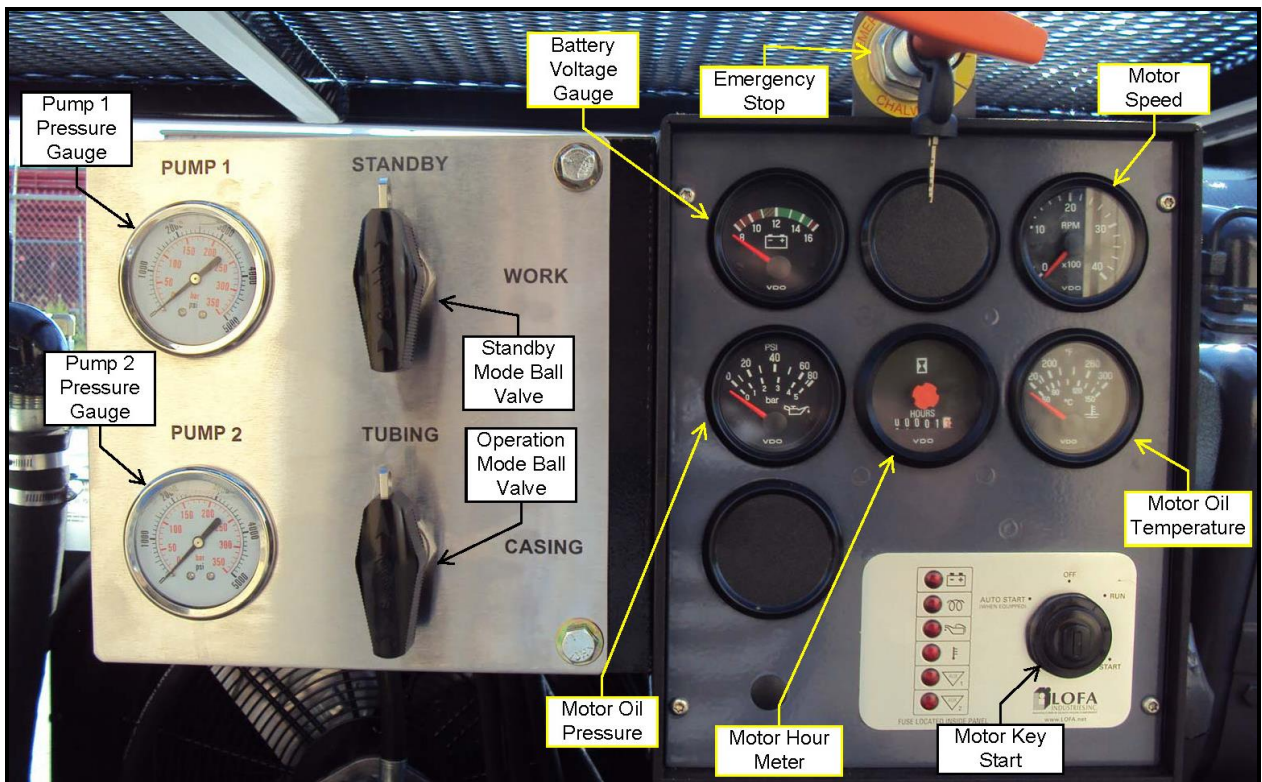

**Figure 6: Control Panel**

### ***Casing Mode***

The power unit should be in casing mode when starting the unit or when a casing tong is to be operated. Casing mode allows both pump sections to contribute flow to the hydraulic circuit, so a higher flow at a lower pressure is available. Once the load on the system

increases past a factory preset point, the rear section of the pump is shifted out of the circuit and circulates fluid internally (tubing circuit mode). Therefore, less flow leaves the pump, but the maximum pressure that can be achieved is higher. This high/low feature allows for faster use of the casing tong with light loads while still providing high pressures for making/breaking of the connection.

### ***Idle Mode***

The power unit is equipped with a hydro-throttle as shown in the figure below. When the system pressure exceeds the set point, the internal piston will extend thereby increasing the motor speed. The cylinder is pushed back by the spring when the pressure drops back down below the set point putting the engine into an idle mode to lower the motor's fuel consumption. The set pressure is typically set around 500 to 800 PSI. This setting should be higher than the back pressure experienced through the interconnect hoses and tong valve in neutral. The setting can be adjusted if the back pressure is higher or lower. Refer to the hydro-throttle cut sheet in the engine section.

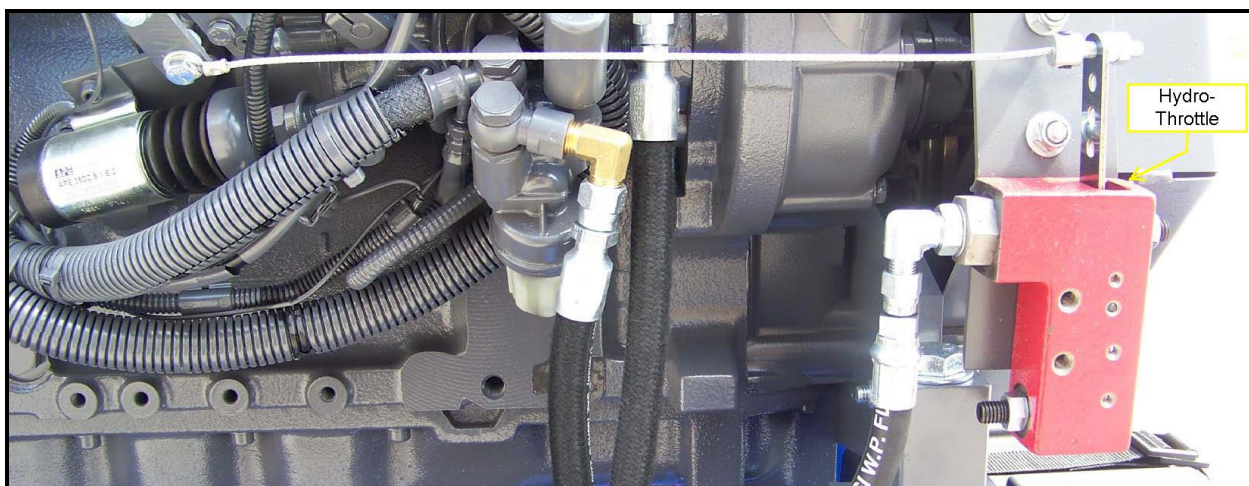

**Figure 7: Hydro-Throttle**

### **Start Up**

Ensure that the installation section has been followed and that the tong control valve handle is in neutral. Review the included engine operation and LOFA panel manuals also prior to operation. To start the power unit, insert the key. Turn the key to the run position. Wait for the preheat LED to go out, then turn the key to the start position. Release the key as soon as the engine starts up. Observe the engine speed, oil temperature and oil pressure gauges. The engine speed will be approximately 1500 RPM when the unit is in idle mode and 2000 RPM otherwise. Consult the engine manual for acceptable ranges for the oil temperature and pressure.



**Figure 8: Return Pressure Gauge**

---

Observe the oil pressure gauges. The system pressure gauge (located on the control panel) will show a low value when the hydraulic oil is circulating directly back to tank. Pressure readings will only occur when the tong is operated. Check the pressure gauge on the return filter assembly at start up. As the filter collects more debris, the pressure drop across the filter increases. If the indicator on the pressure gauge is in the red area, then the return filter element needs replacement.

### **Safety Features**

The power unit is equipped with several safety features, which are explored in more detail in the following sections.

#### ***Engine Silencer***

The exhaust from the engine is routed through a silencer (muffler) to reduce the engine noise. See the location of the silencer in the picture below.

#### ***Engine Spark Arrestor***

After the silencer, the exhaust is routed through a spark arrestor. The spark arrestor, as seen below, uses centrifugal force to separate solids from exhaust gas. The manufacturer recommends inspecting and cleaning out the spark arrestor every 1000 operating hours or three times per season, whichever time period is less. The inspection should include a visual check for holes, cracks or metal corrosion. If any of the above conditions are found, then replace the spark arrestor. Also, ensure the mounting clamp is securely tightened.

The spark arrestor and exhaust are wrapped with a thermal blanket to help prevent the operator from accidentally touching the unit during operation. This area should not be touched even though it contains this safety precaution.



**DO NOT SET TOUCH THE EXHAUST SYSTEM COMPONENTS DURING OPERATION OF THE POWER UNIT AS IT HEATS UP TO DAMAGING TEMPERATURES. THIS HEAT IS RETAINED EVEN AFTER THE POWER UNIT IS TURNED OFF. VERIFY THE UNIT IS COOL BEFORE WORKING AROUND THE EXHAUST SYSTEM.**

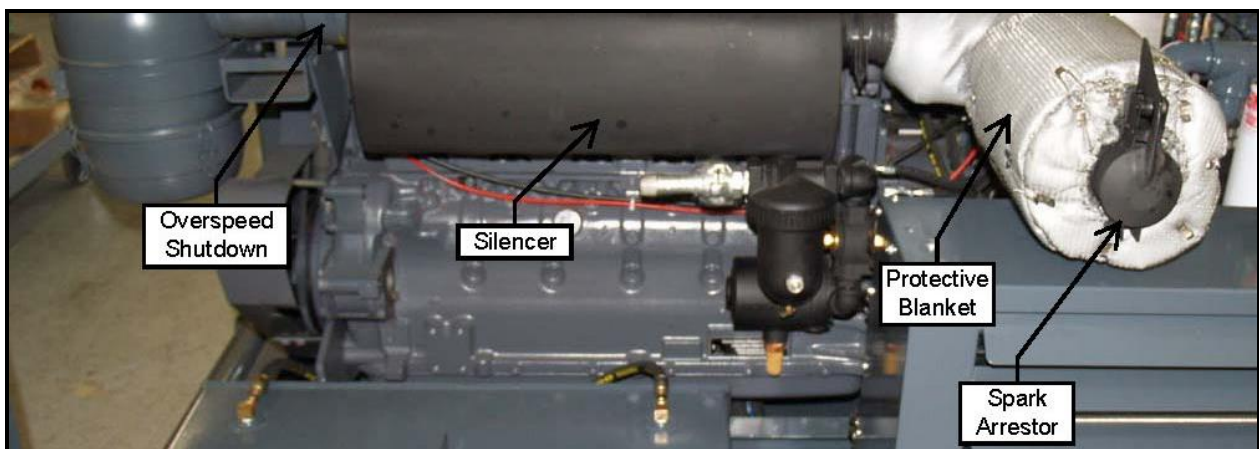

**Figure 9: Engine Exhaust Components and Over Speed Shutdown**

---

## ***Over Speed Shutdown***

If the unit over speeds during a runaway condition such as the intake of gas, then the unit will automatically shut down when the speed exceeds the factory setting of 2400 RPM. The engine should not be restarted again until the area is declared safe for operation. The location of the over speed shutdown is shown in the previous photo. For maintenance and setting instructions, review the over speed shutdown manual.

## ***Emergency Stop Manual Shutdown***

The unit has an emergency stop manual shutdown. Pulling and holding the handle, detailed in the control panel photo, closes off the air intake to shut the engine down. Use this method for emergency situations, not for routine operation. The engine should not be started again until the area is declared safe for operation. The proper way to stop the unit is detailed in the shut down section.

## ***Fan Belt Break***

If the fan belt breaks on the engine, the tension pulley will contact a pressure pin on an electrical switch. A signal is sent to the LOFA control panel and the engine immediately stops. This safety feature prevents the motor from overheating if the cooling fan stops turning due to a belt break. See the figure for the location of the switch.

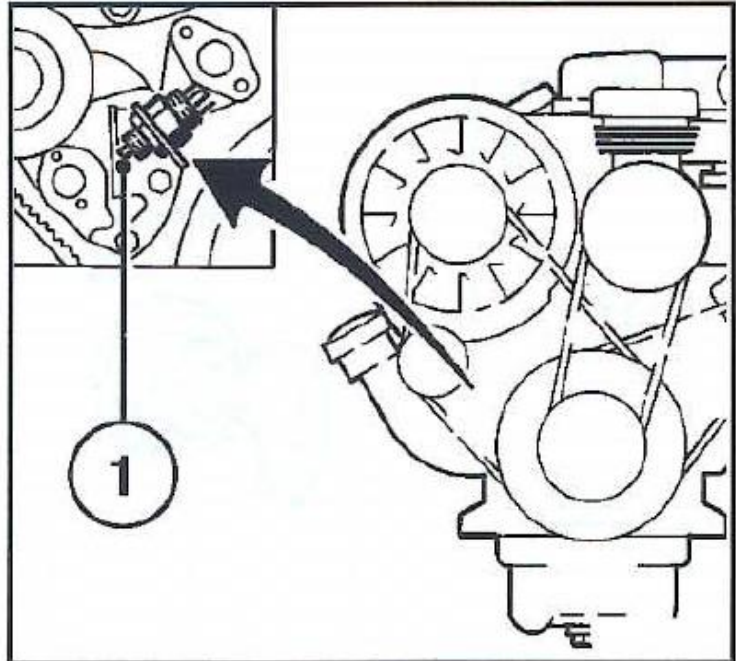

**Figure 10: Fan Belt Break**

## ***Low Oil Pressure/High Oil Temperature Shutdown***

The power unit is set to shut down if the oil pressure gets too low or if the oil temperature gets too high. The LOFA control panel gets these inputs through the engine sensors.

## ***System Relief Valve***

The system hydraulic pressure relief valve (RV-1 on the hydraulic schematic) is shown in the following photo. This valve limits the maximum pressure from the power unit hydraulic pump. It is factory set to relieve at 3000 PSI. To adjust the valve setting, loosen the jam nut on the cartridge valve stem. Turn the screw clockwise to increase the pressure setting and counter clockwise to reduce the setting. Lock the jam nut back down after adjusting the valve setting. To develop pressure in the circuit, either the tong needs to grip and stall on a tool joint or the pressure line can be removed at the quick disconnect (while the unit is off).



**DO NOT SET THE RELIEF VALVE HIGHER THAN THE POWER UNIT DESIGN PRESSURE OR THE ALLOWABLE PRESSURE TO THE COMPONENTS.**



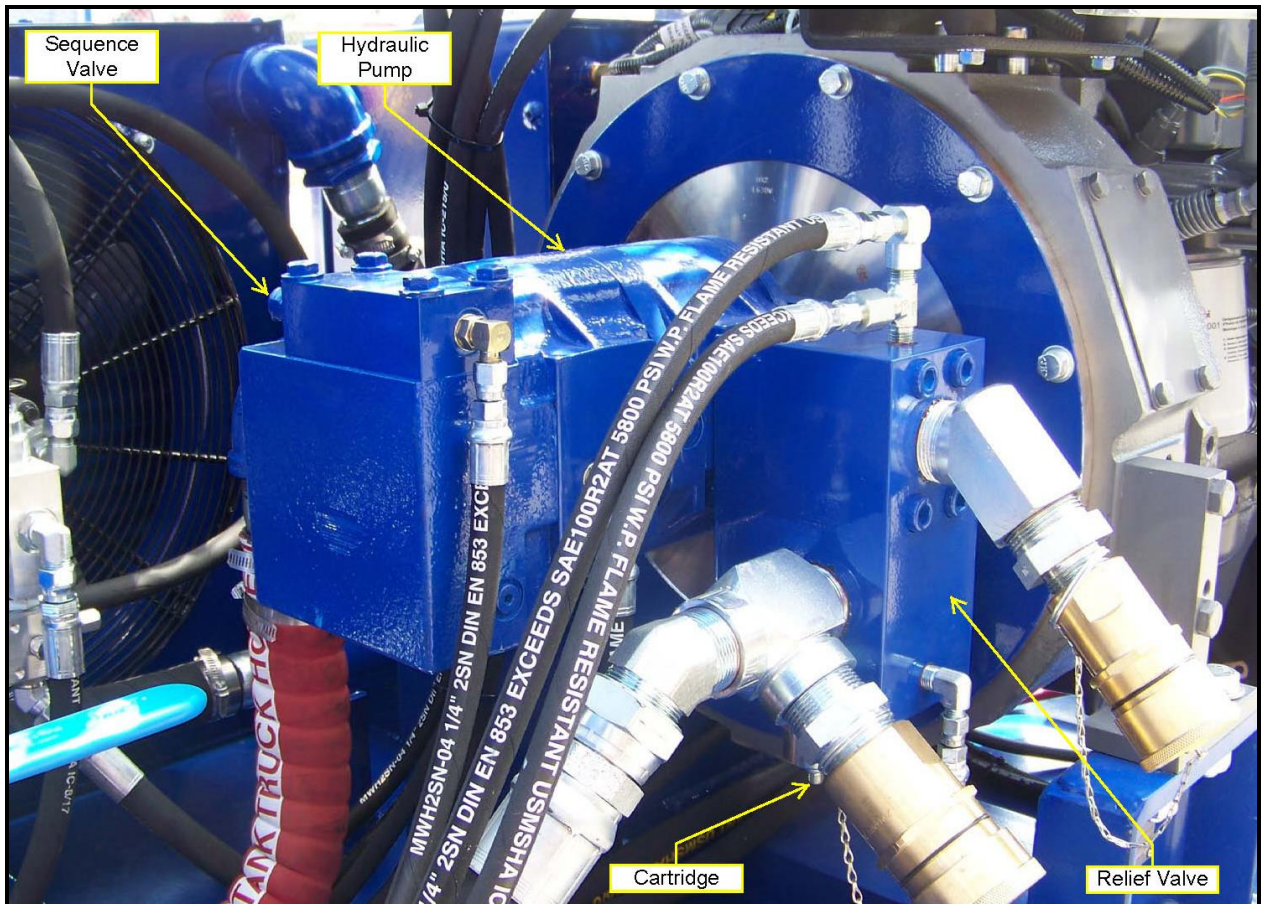

**Figure 11: System Relief and Pump Sequence Valves**

## **Components**

The following sections will explain the major components in the hydraulic system to help the user familiarize themselves with the operation of the power unit. Examine the hydraulic schematic in conjunction with the text below. The assembly drawings will also help identify the physical locations of the components.

### ***Hydraulic Pump***

In the schematic, the hydraulic pump is referenced by HP-1. The pump is a fixed displacement gear pump with two sections, which is connected to the motor (DM-1) using a pump adapter (PA-1) and pump coupling (PC-1).

The pump has an integral high/low circuit as previously discussed. The valve is factory set at 1250 PSI and should not be adjusted in the field. However, the following procedure can be used to set a replacement cartridge in the field.



**DO NOT ATTEMPT TO ADJUST THE PUMP SEQUENCE VALVE WHILE THE UNIT IS RUNNING.**

**DO NOT INCREASE THE SEQUENCE VALVE SETTING PAST 1250 PSI.**

The pump's sequence valve can be seen in the previous picture. With the unit off, remove the cap from the end of the cartridge stem. To adjust the valve setting, loosen the jam nut on the cartridge valve stem. Turn the screw clockwise to increase the pressure setting and counter clockwise to reduce the setting. Lock the jam nut back down after adjusting the valve setting. Upon completion, tighten the cap back onto the cartridge stem.

To check the valve setting, block the pressure port by disconnecting the pressure line at the disconnect. Loosen the jam nut on the system pressure relief valve (RV-1). Lower RV-1's pressure setting all the way by turning the set screw counter-clockwise. Next, start the power unit. Increase the system pressure by turning the RV-1 set screw clockwise. Around 1250 PSI, the pump should shift from high flow to low flow. If it does not shift at 1250 PSI, then shut down the power unit and repeat the adjustment on the HP-1 sequence valve. Continue this trial and error method until the correct setting is achieved. The maximum valve setting is determined by the maximum power the motor can deliver. Increasing the valve setting would increase the required torque from the motor at a higher flow (more power); raising it too high would cause the motor to stall.

### ***Relief Valve***

A relief valve (RV-1) is directly bolted onto the pump's output. This valve limits the maximum pressure on the circuit as mentioned in the system's safety feature section.

### ***Heat Exchanger and Heat Exchanger Hydraulic Pump***

The unit incorporates an air over oil heat exchanger (HX-1) driven by a hydraulic motor. The heat exchanger always runs as long as the power unit motor is running. The hydraulic pump (HP-2) for this circuit is mounted on the motor's auxiliary pad as shown below.

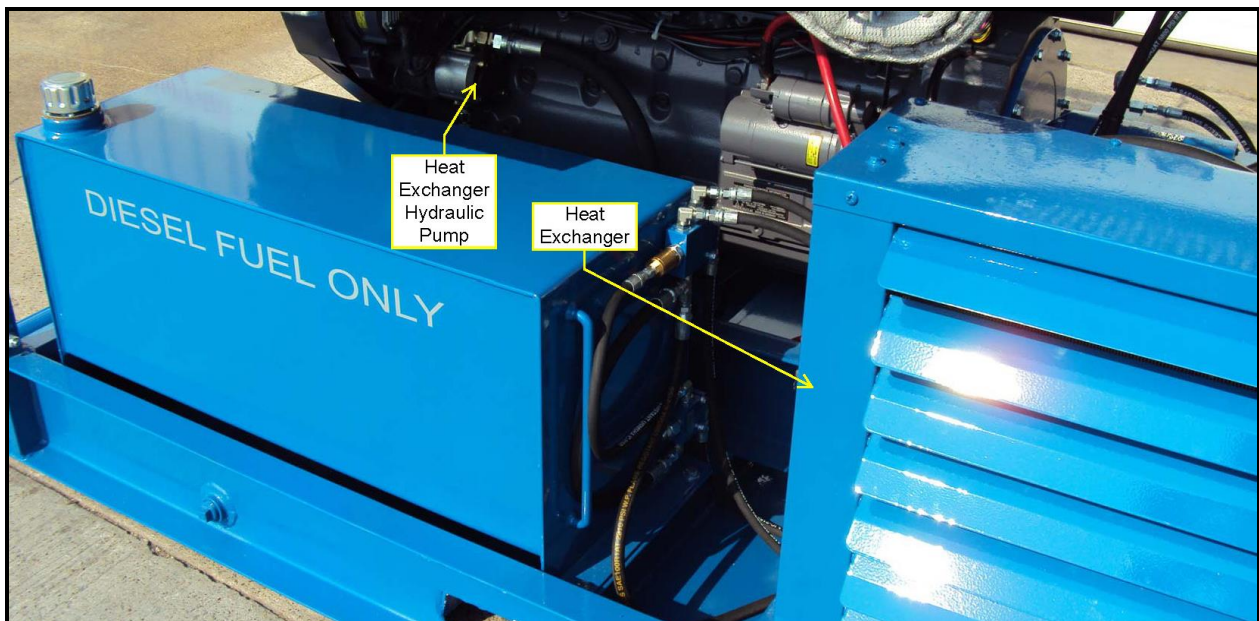

**Figure 12: Heat Exchanger and Pump**

### ***Heat Exchanger Motor Flow Control Valve***

Flow to the heat exchanger hydraulic motor is limited by the control valve (FCV-1) shown in the following photo. This valve keeps the speed of the heat exchanger fan constant no matter if the engine is at full or idle speed. This valve is not adjustable.

## Heat Exchanger Motor Relief Valve

The pressure on the heat exchanger hydraulic motor is restricted by the relief valve (RV-2). This valve is set during the initial test and should not be adjusted in the field.

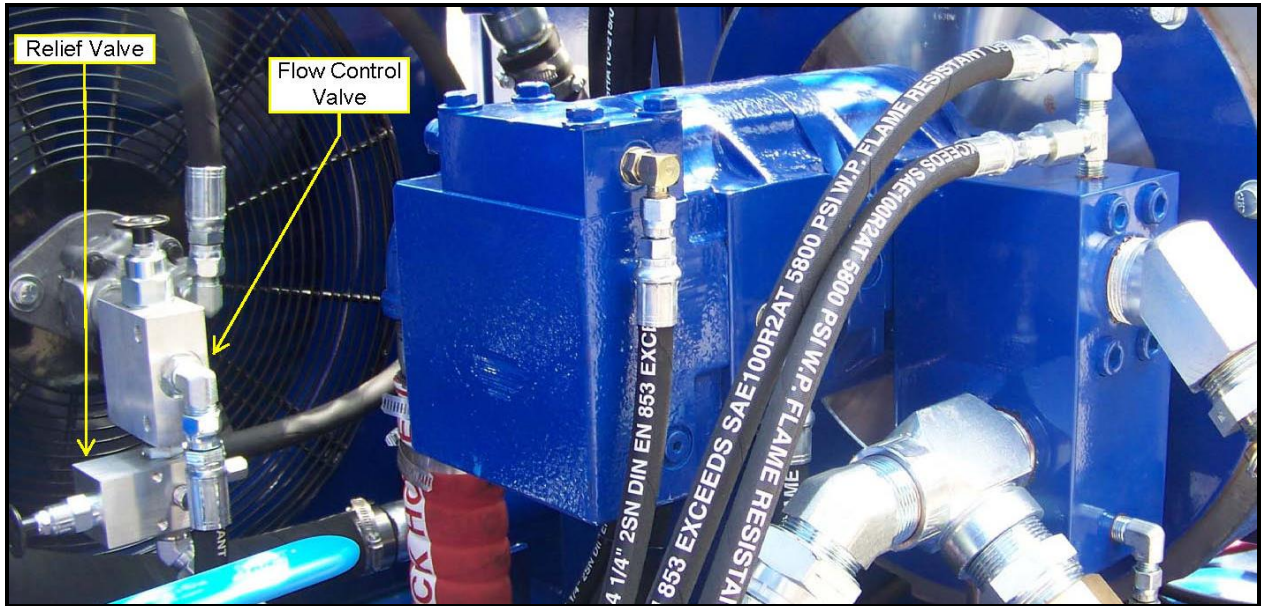

Figure 13: Heat Exchanger Valves

## Suction Strainer

The suction strainer (STR-1) is mounted inside the reservoir. The strainer filters the hydraulic fluid going to the pump inlet.

## Return Filter

Before fluid reenters the reservoir, it passes through the return filter (FL-1).

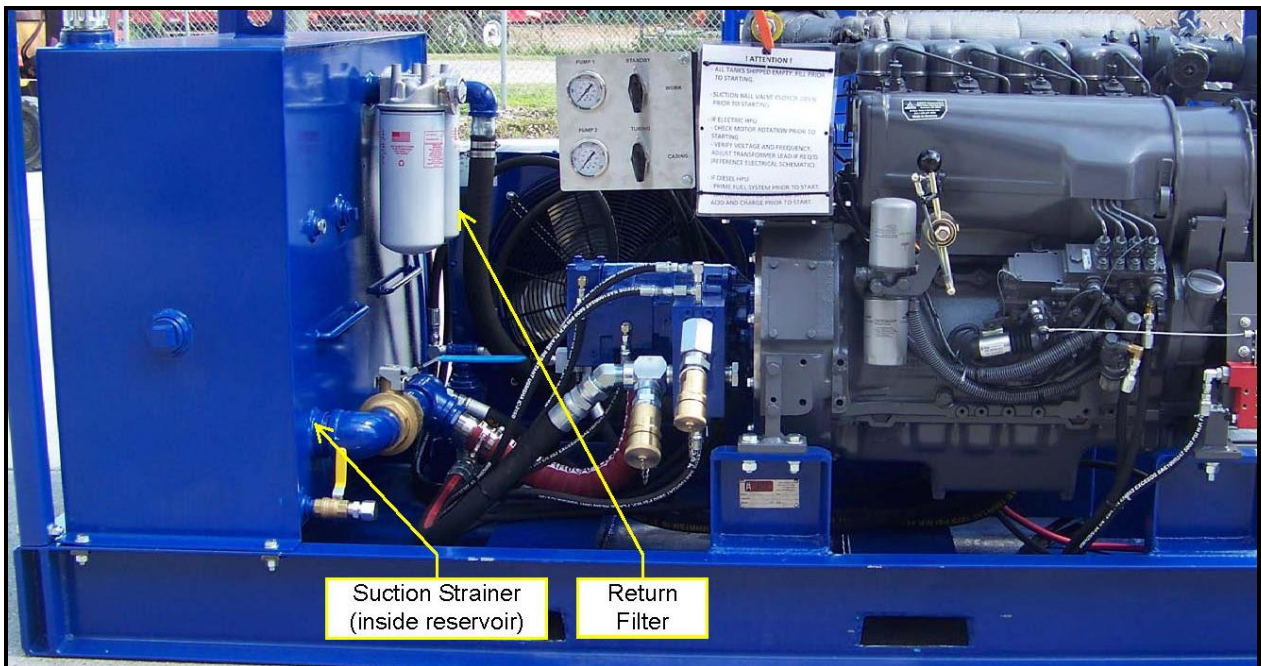

Figure 14: Suction Strainer and Return Filter

---

## **Shutdown**

The proper way to stop the engine is to turn the key from the run to the off position.

- Verify that all operations that the power unit is driving is complete. Do not shutdown while equipment is working.
- Do not stop the engine when it is running at full load. Instead, allow the engine to cool down by letting it run at idle speed for some time.

## **Storage**

Follow the steps below when removing the power unit from operation.

- Stop the diesel engine.
- Disconnect the pressure and return lines from the power unit and from the tong. Install the dust plugs and caps onto the exposed quick disconnects. Coil the hydraulic lines and place them into the storage basket on the lift frame.
- Move the power unit to its storage location.
- Clean and remove all debris from the power unit. Afterwards, inspect the unit for any damage. Address all problems identified.
- Perform any required routine maintenance on the power unit.

## **Troubleshooting**

The following table addresses possible solutions to problems that may occur during operation. When a problem occurs, take note of the problem as well as the operation being performed when the malfunction happened. Also, note if there has been any recent maintenance or adjustments to the power unit. All these items will be helpful in diagnosing the problem. Use the problem information to search the following tables of symptoms to troubleshoot the hydraulic power unit. Always follow safety guidelines while troubleshooting the unit.

**Table 1: Troubleshooting the Power Unit Engine**

Problem	Solution
Engine will not start	<ol style="list-style-type: none"><li>1) Verify the battery cables are connected and that the battery has a charge.</li><li>2) Check the fan belt. Replace the belt if broken.</li><li>3) Ensure the manual shutdown pull handle is not stuck in the out position. Reset by pushing in if required.</li><li>4) Verify the diesel tank is not empty. If the unit was allowed to run dry, then vent air out of the fuel lines per the engine manual.</li><li>5) Make sure the fuel filter is not clogged. Replace the filter if blocked by debris, and vent the fuel system.</li><li>6) Inspect the fuel pump strainer for blockage. If dirty, then wash per the engine manual then replace. Vent the air out of the fuel system.</li><li>7) Ensure the correct grade of diesel fuel is utilized.</li><li>8) Add fuel additives, per the engine manual, if the operating temp. is below the start limit temperature.</li><li>9) Inspect the fuel lines and fittings for leaks or entry points for air to enter the system. Vent the fuel system</li></ol>

	<p>after addressing the problem.</p> <p>10) Inspect and replace the fuel injector if it is defective.</p> <p>11) Verify the engine inlet-outlet valve clearance is per the engine manual's recommendation. Adjust if required.</p> <p>12) Verify the correct motor oil is being used especially in low temperature environments. Refer to the engine manual for further guidance.</p> <p>13) Check the compression of the diesel engine. Service engine if required.</p>
Engine stalls or sputters/runs unevenly	<p>1) Ensure the correct grade of diesel fuel is utilized.</p> <p>2) Inspect the fuel lines and fittings for leaks or entry points for air to enter the system. Vent the fuel system after addressing the problem.</p> <p>3) Inspect and replace the fuel injector if it is defective.</p> <p>4) Make sure the fuel filter is not clogged. Replace the filter if blocked by debris, and vent the fuel system.</p> <p>5) Inspect the fuel pump strainer for blockage. If dirty, then wash per the engine manual then replace. Vent the air out of the fuel system.</p> <p>6) Verify the engine inlet-outlet valve clearance is per the engine manual's recommendation. Adjust if required.</p>
Engine speed does not return to idle after operation	<p>1) Lower the set point of the hydro-throttle.</p> <p>2) Verify hydro-throttle spring is functioning properly. Replace if damaged.</p> <p>3) Ensure the spring on the engine throttle is returning the lever to idle. Replace if damaged.</p>
Motor stops unexpectedly	<p>1) Check the fan belt. Replace the belt if broken. Inspect only when the engine is stopped and not running!</p> <p>2) Verify the diesel tank is not empty. If the unit was allowed to run dry, then vent air out of the fuel lines per the engine manual.</p> <p>3) Check for low oil pressure or high oil temperature.</p> <p>4) Ensure the manual shutdown pull handle is not stuck in the out position. Reset by pushing in if required.</p> <p>5) Check the pressure setting on the hydraulic pump. If it is set too high, then the engine can stall out when the tong is stalled during make or break.</p> <p>6) Verify that the engine speed does not exceed the setting of the over speed safety feature. Adjust the maximum travel set screw if necessary.</p>
Engine oil pressure is low	<p>1) Verify the motor level is at the correct height. Fill up if the level is low.</p> <p>2) Check the motor oil and replace if it is the wrong SAE grade or if the oil is of poor quality.</p> <p>3) Inspect the engine for excessive inclination. Replace or rebuild the diesel motor if required.</p>
Engine runs too hot	<p>1) Verify the motor level is at the correct height. Fill up if</p>

	<p>the level is low and drain if too high.</p> <p>2) Inspect the engine air filter for debris. Clean or replace if clogged.</p> <p>3) Ensure the engine fan blade is turning. Inspect the tension in and condition of the fan belt. Replace if the belt is worn. Adjust idler to maintain correct tension. Never inspect or operate on the fan system with the diesel engine running!</p> <p>4) Inspect and replace the fuel injector if it is defective.</p>
Engine creating excessive blue colored smoke	<p>1) Replace motor oil if the wrong grade or of poor quality.</p> <p>2) Inspect the engine for excessive inclination. Replace or rebuild the diesel motor if required.</p> <p>3) Check the motor oil level to ensure it is not too high.</p> <p>4) Verify fluid in the oil bath air cleaner is not too high.</p>
Engine creating excessive white colored smoke	<p>1) Ensure the correct grade of diesel fuel is utilized.</p> <p>2) Add fuel additives, per the engine manual, if the operating temperature is below the start limit temperature.</p> <p>3) Verify the engine inlet-outlet valve clearance is per the engine manual's recommendation. Adjust if required.</p> <p>4) Inspect and replace the fuel injector if it is defective.</p>
Engine creating excessive white colored smoke	<p>1) Ensure the oil bath air cleaner is clean and not contaminated with debris.</p> <p>2) Verify the engine inlet-outlet valve clearance is per the engine manual's recommendation. Adjust if required.</p> <p>3) Inspect and replace the fuel injector if it is defective.</p>

**Table 2: Troubleshooting the Power Unit Hydraulic Circuit**

Problem	Solution
Power unit performance is poor	<p>1) If the flow rate seems low, then verify the operation mode handle is in the correct position. When in tubing mode, the flow is limited to a smaller volume.</p> <p>2) If the flow rate seems low, then make sure the hydraulic throttle is shifting as required. Ensure that the throttle needle valve has not been closed by accident. It is supposed to be opened one turn from fully closed.</p> <p>3) Check the motor oil level to ensure it is not too high.</p> <p>4) Inspect the engine air filter for debris. Clean or replace if clogged.</p> <p>5) Make sure the fuel filter is not clogged. Replace the filter if blocked by debris, and vent the fuel system.</p> <p>6) Inspect the fuel lines and fittings for leaks or entry points for air to enter the system. Vent the fuel system after addressing the problem.</p> <p>7) Verify the engine inlet-outlet valve clearance is per the engine manual's recommendation. Adjust if required.</p> <p>8) Inspect and replace the fuel injector if it is defective.</p>

	<p>9) Inspect the hydraulic system for an excessive pressure drop, which could be caused by any of the following.</p> <ul style="list-style-type: none"> <li>a) Verify the quick disconnects are completely tightened and engaged.</li> <li>b) Inspect the return filter pressure gauge. Replace the filter elements if required.</li> <li>c) Ensure the hoses are adequate for the power unit flow (1" for pressure, 1-1/4" for return).</li> </ul> <p>10) Verify the correct viscosity of fluid is utilized for the operating temperature. Change fluids if necessary.</p> <p>11) Check the hydraulic fluid temperature. If too hot, then allow the unit to cool. Inspect the heat exchanger fins, and clean if clogged with debris. Verify the fan motor is spinning.</p>
Power unit comes out of idle position slowly	<p>1) Inspect the hydro-throttle for proper operation and replace or rebuild as necessary.</p> <p>2) If the ambient temperature is low, then warm up the power unit to raise the hydraulic fluid temperature and lower the viscosity.</p> <p>3) Verify the correct viscosity of hydraulic fluid is used for the operating temperature. Change fluids if necessary.</p>
Hydraulic pump operation is excessively noisy	<p>1) Verify the correct viscosity of hydraulic fluid is being utilized for the operating temperature. Change fluids if necessary.</p> <p>2) Ensure that air is not entering the suction lines of the pump. Check for leaks in the line.</p> <p>3) Inspect the fluid level of the hydraulic reservoir. If the level is below the sight glass, then add hydraulic fluid.</p> <p>4) Excessive noise, vibration and heat would be generated from the pump if the bearings are worn or damaged. Rebuild or replace the pump.</p>
Reservoir level gauge or pressure gauge is showing contamination	<p>1) If the ambient temperature is low, then warm up the power unit to raise the hydraulic fluid temperature and lower the viscosity.</p> <p>2) Inspect the return filter element. Replace if it is contaminated.</p> <p>3) Take a sample from the tank drain port. If contaminated, then replace the hydraulic fluid in the tank after cleaning the tank's interior.</p>
Hydraulic fluid temperature is too high	<p>1) Verify the correct viscosity of hydraulic fluid is being utilized for the operating temperature. Change fluids if necessary.</p> <p>2) Inspect the heat exchanger fins, and clean if clogged with debris. Verify the fan motor is spinning.</p> <p>3) Inspect the fluid level of the hydraulic reservoir. If the level is below the sight glass, then add hydraulic fluid.</p> <p>4) Inspect the hydraulic system for an excessive pressure</p>

	<p>drop, which could be caused by any of the following.</p> <ul style="list-style-type: none"> <li>a) Verify the quick disconnects are completely tightened and engaged.</li> <li>b) Inspect the return filter pressure gauge. Replace the filter elements if required.</li> <li>c) Ensure the hoses are adequate for the power unit flow (1" for pressure, 1-1/4" for return).</li> </ul> <p>5) Ensure the power unit is connected to an open centered valve not a closed center valve.</p>
Tong torque is low	<ul style="list-style-type: none"> <li>1) Verify the setting of the pressure relief valve (RV-1) is not set too low. Adjust to the desired pressure. Increase the valve setting while applying torque to the joint.</li> <li>2) Inspect the pressure gauge for correct operation. Check the tong torque output against a tension type tong torque gauge if available.</li> <li>3) If the hydraulic pump is damaged, then rebuild or replace the pump.</li> </ul>
Tong rotates slowly	<ul style="list-style-type: none"> <li>1) If the flow rate seems low, then make sure the hydro-throttle is operating as designed.</li> <li>2) Inspect the hydraulic system for an excessive pressure drop, which could be caused by any of the following. <ul style="list-style-type: none"> <li>a) Verify the quick disconnects are completely tightened and engaged.</li> <li>b) Inspect the return filter pressure gauge. Replace the filter elements if required.</li> <li>c) Ensure the hoses are adequate for the power unit flow (1" for pressure, 1-1/4" for return).</li> </ul> </li> </ul>

## **Maintenance**

It is important to maintain the power unit in a condition that will provide continued safe operation. The following sections highlight items that need to be addressed over the life of the unit.

### ***Before Each Job***

1. Fill up the diesel fuel tank. If the engine has been run until the tank is empty, then bleed the air out of the fuel system.
2. Inspect the unit visually and look for signs of damage or leaks. Check all components (hydraulic and mechanical). Ensure all hydraulic hoses, including the interconnects, are free of damage.
3. Check the fluid level of the hydraulic reservoir.
4. Clean the engine air intake pre-cleaner.
5. Inspect the engine air intake oil bath air cleaner. Clean if required. Frequency of cleaning is dictated by the amount of the dust in the air when operating.
6. Check the engine motor oil level.
7. Clean the heat exchanger fins.
8. Set the system relief pressure to the required level for the job.
9. Verify the manual air intake shutdown safety feature functions properly.
10. Drain water accumulation from the bottom of the reservoir (after settled).



---

### ***Each 500 Hour Interval***

1. Inspect the fan belt for damage. Replace if worn.
2. Replace the hydraulic return filter elements.
3. Change the engine motor oil and replace the oil filter.

### ***Each 1000 Hour Interval***

1. Replace the hydraulic oil in the reservoir. When the tank is empty, clean the interior with a lint free cloth to remove any debris deposited in the bottom. Also, clean or replace the suction strainers if contaminated.
2. Clean the fuel strainer on the engine.
3. Replace the fuel filter on the engine.
4. Check the valve clearance on the engine; adjust if necessary.

### ***Each 1 Month Interval***

1. Clean the spark arrestor on the engine.

### ***Each 3 Month Interval***

1. Verify the function of the automatic over speed shutdown. It may be necessary to adjust the maximum speed set screw to allow the engine to increase its speed. All settings must be returned to the correct position after the test.
2. Ensure the fan belt safety switch functions properly. Do not put hands into the fan belt area while the engine is running.

### ***Hoses***

Replace the hoses within appropriate intervals regardless of the condition. Every five years is the usual hose manufacturer time frame.

### **One Year Spares**

Below is a list of recommended spares for one year of operation.

**Table 3: One Year Spares**

<b>Part Number</b>	<b>Qty.</b>	<b>Parts Description</b>
81021-RE	4	Return filter element
81021-RG	1	Return filter pressure gauge
81044	1	Suction strainer
81018	1	System pressure gauge
81072-C	1	System relief valve cartridge
81075-C	1	Pump sequence valve cartridge
81075-SK	1	Pump seal kit
30131-LG	1	Level gauge for hydraulic tank
30131-FB	1	Filler/breather cap for hydraulic tank
80021-FF	2	Engine fuel filter
80021-OF	2	Engine oil filter
80021-FB	1	Engine fan belt
80002	1	Engine to pump shaft coupling
30851-LG	1	Level gauge for fuel tank

**Table 4: Two Year Spares**

<b>Part Number</b>	<b>Qty.</b>	<b>Parts Description</b>
81021-RE	8	Return filter element
81021-RG	2	Return filter pressure gauge
81044	2	Suction strainer
81018	2	System pressure gauge
81072-C	1	System relief valve cartridge
81075-C	1	Pump sequence valve cartridge
81075-SK	1	Pump seal kit
30131-LG	1	Level gauge for hydraulic tank
30131-FB	1	Filler/breather cap for hydraulic tank
80021-FF	4	Engine fuel filter
80021-OF	4	Engine oil filter
80021-FB	2	Engine fan belt
80002	1	Engine to pump shaft coupling
30851-LG	1	Level gauge for fuel tank
81075	1	Hydraulic pump (see note)

Note: International customers should consider the purchase of a spare hydraulic pump.

## **Appendices**

The following appendices contain further detailed information about the power unit. Cut sheets for the major components are also included.

- Section 2: Power Unit Mechanical Drawings
- Section 3: Power Unit Hydraulic Drawings and Cut Sheets
- Section 4: Engine Information and Cut Sheets
- Section 5: Test Sheet and Material Reports